

# User's Manual

## CNPS8900 Series

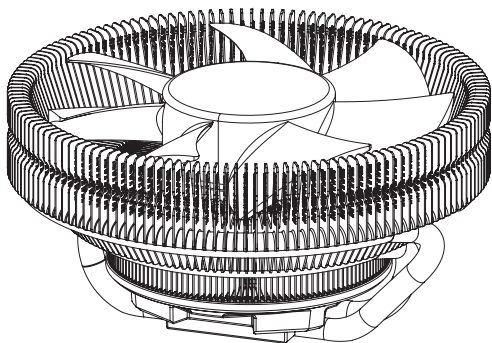

**Intel** Socket 1366/1156/1155/775 CPUs

**AMD** Socket FM2/FM1/AM3+/AM3/AM2+/AM2 CPU&APUs

To ensure safe and easy installation, please read the following precautions.

[www.ZALMAN.com](http://www.ZALMAN.com)

## 1. Precautions

- 1) Avoid inserting objects or hands into the fan while it is in operation to prevent product damage and injuries.
- 2) Do not ingest the Thermal Grease, and avoid its contact with skin and eyes. If contact is made with skin, wash off with water. If ingested or irritation persists, seek medical attention.
- 3) To prevent possible injuries, gloves must be worn while handling this product.
- 4) Excessive force exerted on the fan may cause damage to the fan and/or system.
- 5) Use and keep product away from reach of children.
- 6) Check the components list and condition of the product before installation. If any problem is found, contact the retailer to obtain a replacement.
- 7) During transportation of the system, the cooler must be removed. Zalman is not responsible for any damages that occur during the transport of a system.
- 8) Product design and specifications may be revised to improve quality and performance.

Disclaimer) Zalman Tech Co., Ltd. is not responsible for any damages due to external causes, including but not limited to, improper use, problems with electrical power, accident, neglect, alteration, repair, improper installation, or improper testing.

## 2. Specifications

Model		CNPS8900 Extreme	CNPS 8900 Quiet
Spec.			
Material		Pure Copper and Aluminum	
Weight		400g	
Dimensions		120(L) x 120(W) x 60(H)mm	
Fan	Bearing	2 Ball-Bearing	Long Life Bearing
	RPM	1,250~2,800 rpm $\pm$ 10%	1,000~1,500 rpm $\pm$ 10%
	Noise Level	19.5 ~ 35dBA $\pm$ 10%	19 ~ 25dBA $\pm$ 10%
	Input Voltage	12V	

## 3. Installation Requirements

### 1) Space Requirements

The cooler's installation requires an unobstructed space of 120mm(width), 120mm(length), and 60mm(height), with the CPU as a central reference point. Please check if components such as ODDs and PSU protrude into the required space.

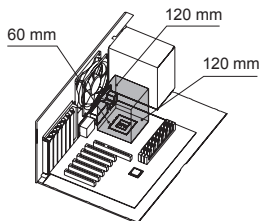

## 4. Components

### 1) Common Components

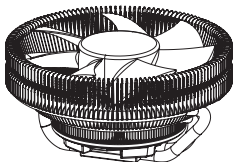

Cooler

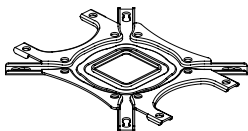

Backplate



Side Caps



Nuts



User's Manual



Bolts (Cooler)



Bolts (Clip)



Extension Fan Cable

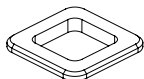

Loading Block

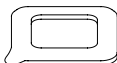

Double-sided Tape



Thermal Grease  
(ZM-STG2M)

### 2) Intel Components

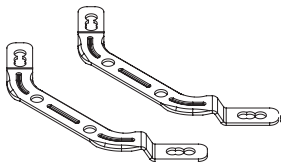

Intel Clip  
(Socket 1366/1156/1155/775)

### 3) AMD Components

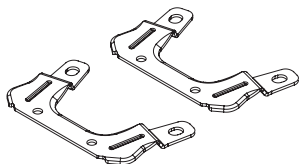

AMD Clip  
(Socket FM2/FM1/AM3+/AM3/AM2+/AM2)

## 5. Installation

## ! Common

Connect the extension fan cable to the fan connector of cooler.

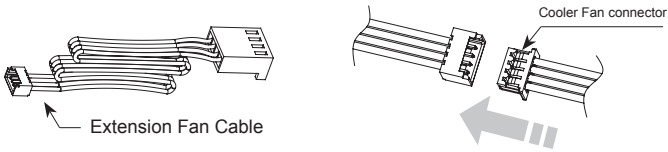

## A. Intel Socket 1366/1156/1155/775 Installation

- ① Install the Intel clip to the base of cooler using the bolts (Clip).  
Please make sure to put the curved part of clip toward the base as shown in the image.

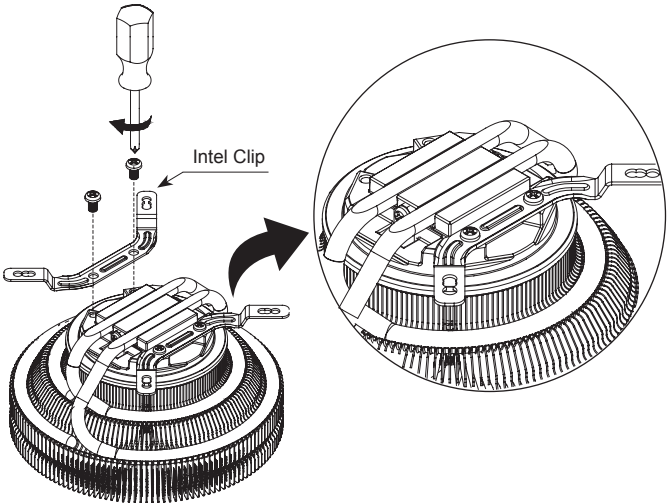

- ② Install the side cap to the Backplate according to a socket type.

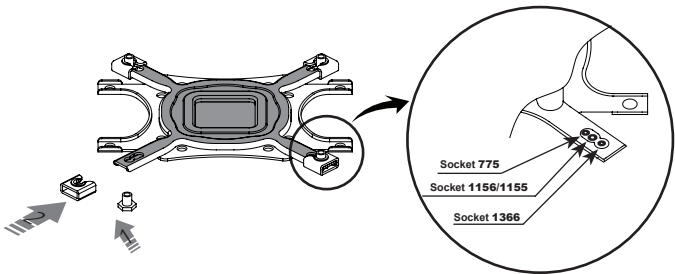

**⚠ Caution**

Please note the orientation of the Nuts and the Side Caps.

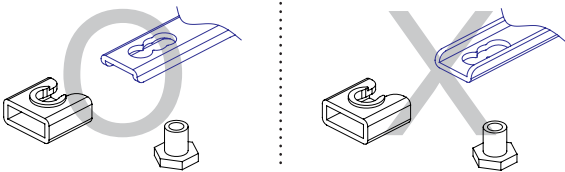

- ③ Socket 1366/1156/1155 Installation

Attach Double-sided Tape to the center of the Backplate and remove the Double-sided Tape's Cover.

※ Installation of Socket 1366/1156/1155 does not require the Loading Block.

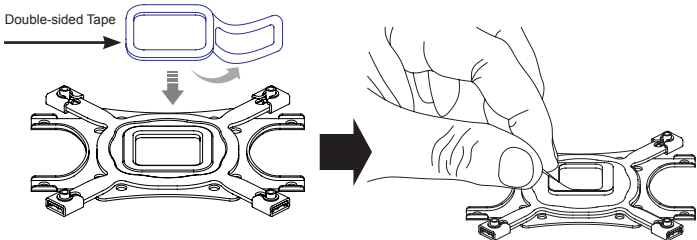

## ④ Socket 775 Installation

Remove the Sticker Cover from the Lower Tier of the Loading Block and attach to the Backplate.

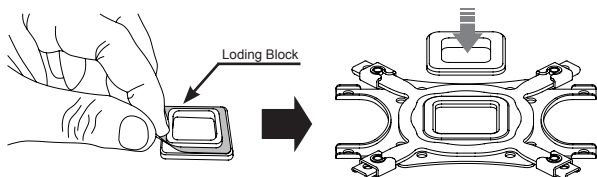

Attach Double-sided Tape to the Loading Block and remove the Double-sided Tape Cover.

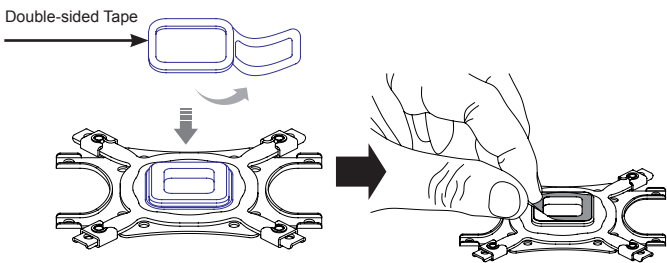

**⚠ Caution**

Please note of the orientation of the Loading Block's Installation.

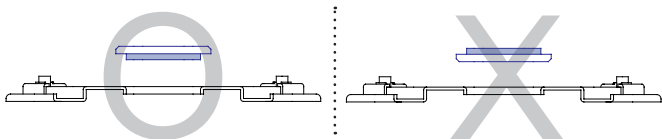

- ⑤ Align the Backplate's holes with motherboard's clip support holes, attach it to the back side of the motherboard.

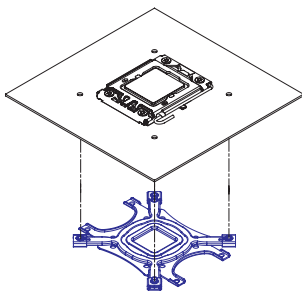

- ⑥ Spread the Thermal Grease on the CPU's surface and put the Cooler on the center of CPU and then fasten the Bolts (Cooler) to install the Cooler.

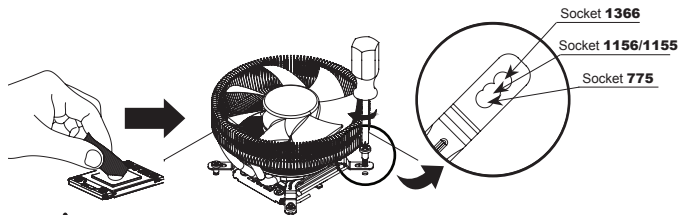

**! Caution**

In the case of Tower Enclosure, the direction of heatpipe to be horizontally as shown in the image. The vertical installation can affect the performance of heat dissipation.

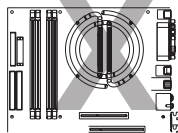
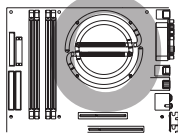

- ⑦ Connect the cooler's 4-pin connector to the motherboard's CPU Fan header.

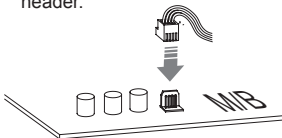

**! Caution**

Please make sure that PWM Control Mode is activated in the motherboard's BIOS settings.

## B. AMD Socket FM2/FM1/AM3+/AM3/AM2+/AM2 Installation

- ① Install the AMD Clip to the base of cooler using the bolts (Clip).  
Please make sure to put the curved part of clip toward the base as shown in the image.

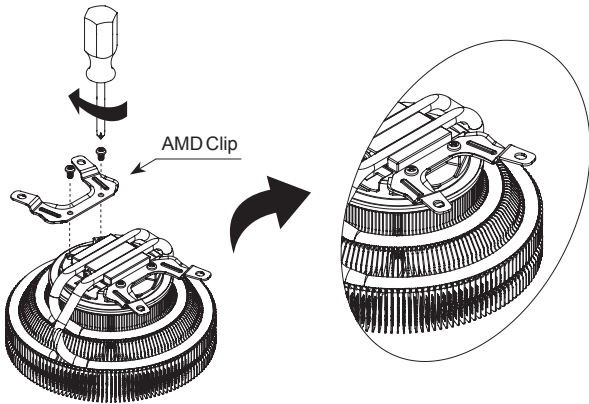

- ② Install the side cap to the Backplate.

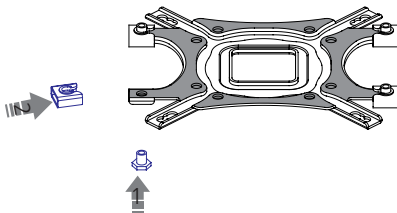

**Caution**

Please note of the orientation of Nuts and side Caps.





- ③ Remove the Sticker Cover from the Lower Tier of the Loading Block and attach to the Backplate.

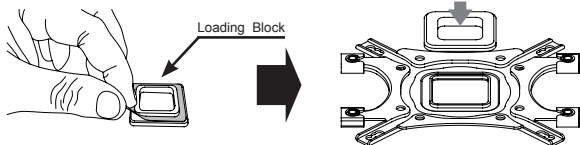

Attach Double-sided Tape to the Loading Block and remove the Double-sided Tape Cover

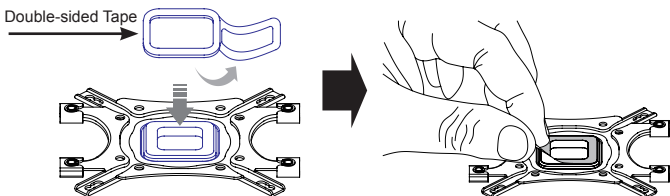

### ⚠ Caution

Please note of the orientation of the Loading Block's Installation.

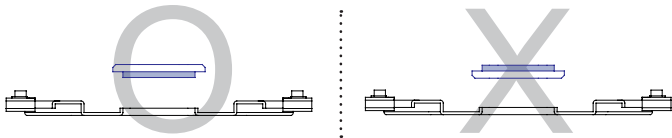

- ④ Take away the fixed Clip support from the motherboard.

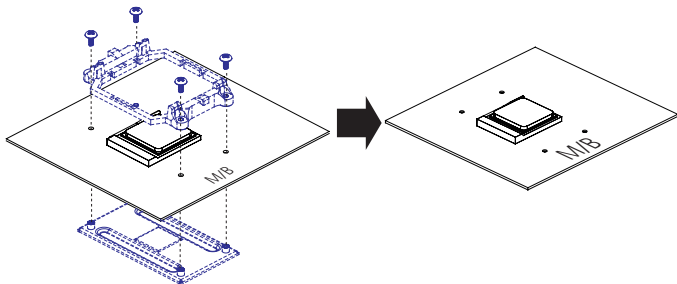

- ⑤ Align the Backplate's holes with motherboard's clip support holes, attach it to the back side of the motherboard.

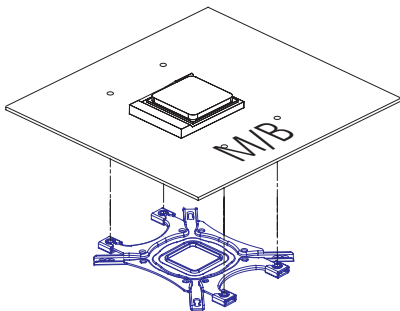

- ⑥ Spread the Thermal Grease on the CPU's surface and put the Cooler on the center of CPU and then fasten the Bolts (Cooler) to install the Cooler.

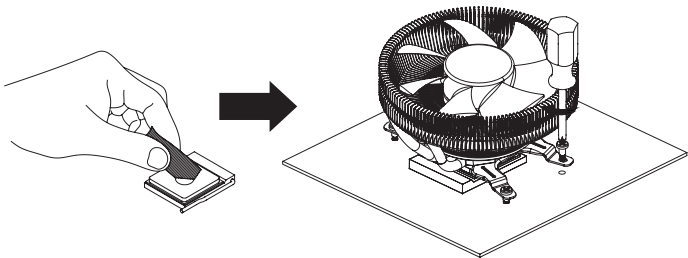

- ⑦ Connect the cooler's 4-pin connector to the motherboard's CPU Fan header.

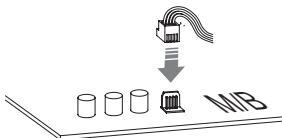

**! Caution**

Please make sure that PWM Control Mode is activated in the motherboard's BIOS settings.

# McGrp.Ru



## Сайт техники и электроники

Наш сайт [McGrp.Ru](http://McGrp.Ru) при этом не является просто хранилищем [инструкций по эксплуатации](#), это живое сообщество людей. Они общаются на форуме, задают вопросы о способах и особенностях использования техники. На все вопросы очень быстро находят ответы от таких же посетителей сайта, экспертов или администраторов. Вопрос можно задать как на форуме, так и в специальной форме на странице, где описывается интересующая вас техника.