

7

8

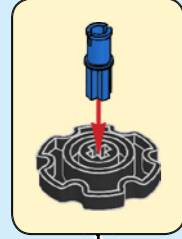

9

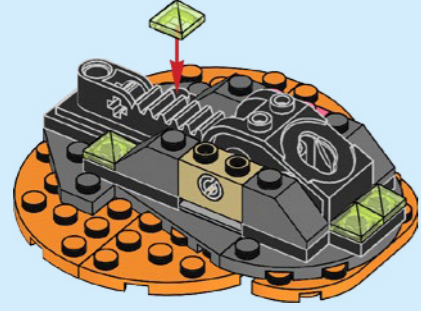
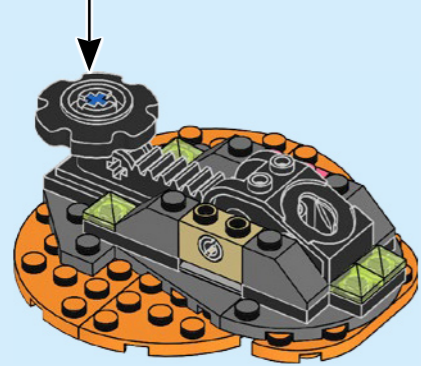

1

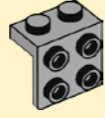

2

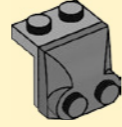

2x

10

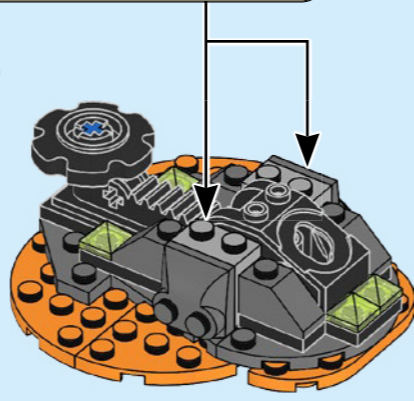

11

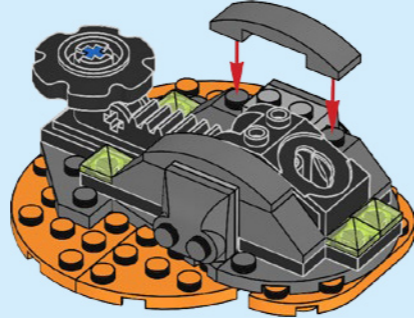

12

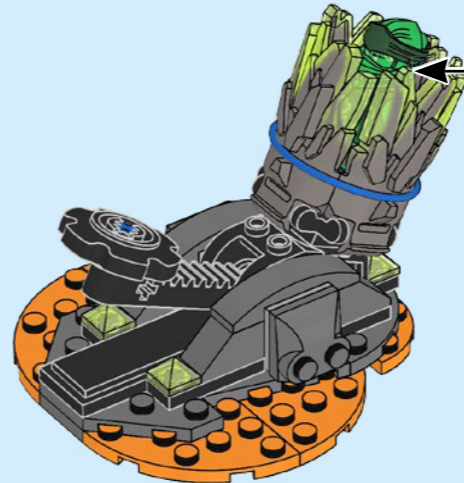
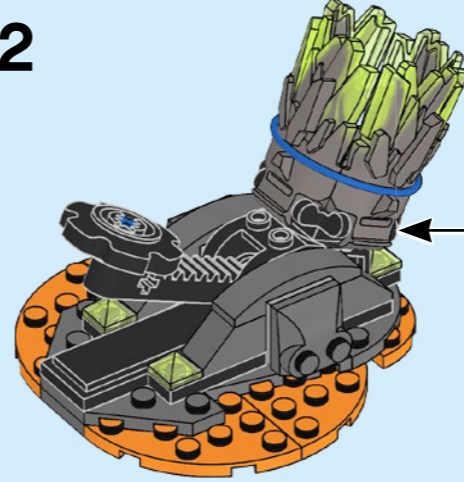

1

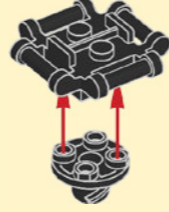

2



3



Terms & Conditions apply

**WIN**  
GO TO [WWW.LEGO.COM/PRODUCTFEEDBACK](http://WWW.LEGO.COM/PRODUCTFEEDBACK) ABOUT THIS SET TO WIN A COOL LEGO PRIZE.

[LEGO.com/productfeedback](http://LEGO.com/productfeedback)

GEWINNE

Erzähle uns auf [www.LEGO.com/productfeedback](http://www.LEGO.com/productfeedback)

etwas über die Erfahrungen, die du mit diesem LEGO® Set gemacht hast, und sichere dir die Chance auf einen coolen LEGO Preis!

Es gelten die Teilnahmebedin-

GAGNE

Rends-toi sur [www.LEGO.com/productfeedback](http://www.LEGO.com/productfeedback)

et donne-nous quelques commentaires sur ce produit LEGO® pour avoir une chance de gagner un prix LEGO!

Voir Conditions Générales

GANA

Visita [www.LEGO.com/productfeedback](http://www.LEGO.com/productfeedback)

y envíanos tu opinión acerca de este set LEGO®, ¡Participaras en el sorteo de un premio LEGO!

Términos y Condiciones aplicables

获取奖品

登录 [www.LEGO.com/productfeedback](http://www.LEGO.com/productfeedback)

给出关于此乐高®套装的简短反馈，就有机会获得炫酷乐高奖品

《条款及条件》适用

[LEGO.com/NINJAGO](http://LEGO.com/NINJAGO)

[LEGO.com/service](http://LEGO.com/service)

LEGO, the LEGO logo, NINJAGO and the NINJAGO logo are trademarks of the/son des marques de commerce du/son marcas registradas de LEGO Group.  
©2020 The LEGO Group. 6326505/6326549