

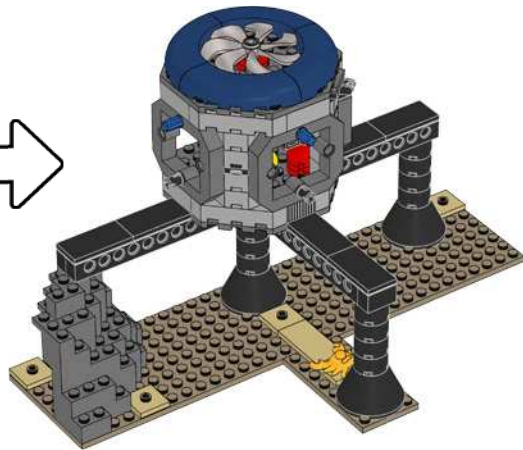

CITY

60265

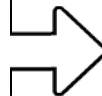

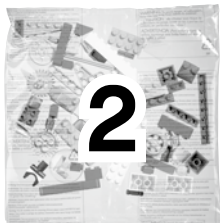
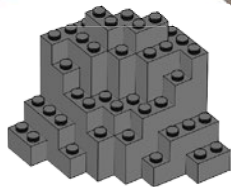
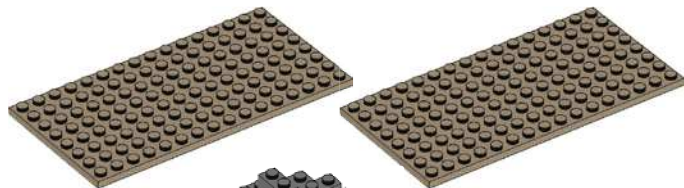

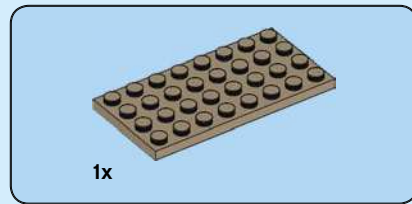

1

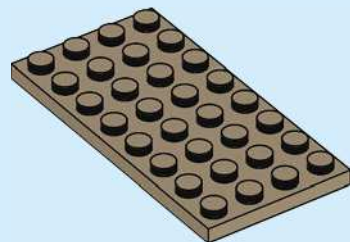

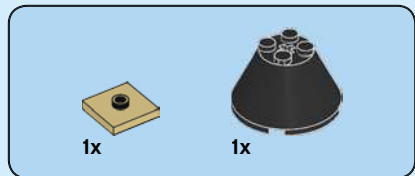

2



4

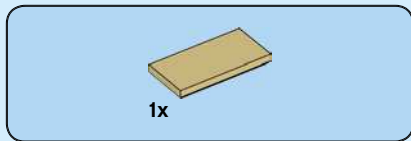

3

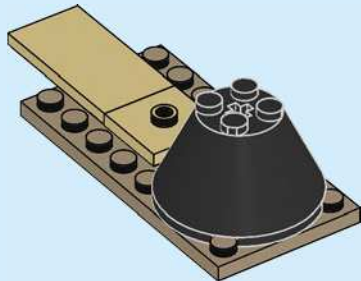

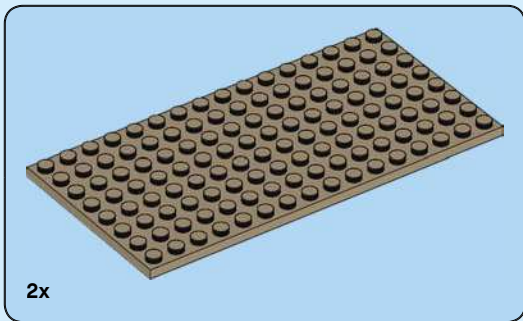

4

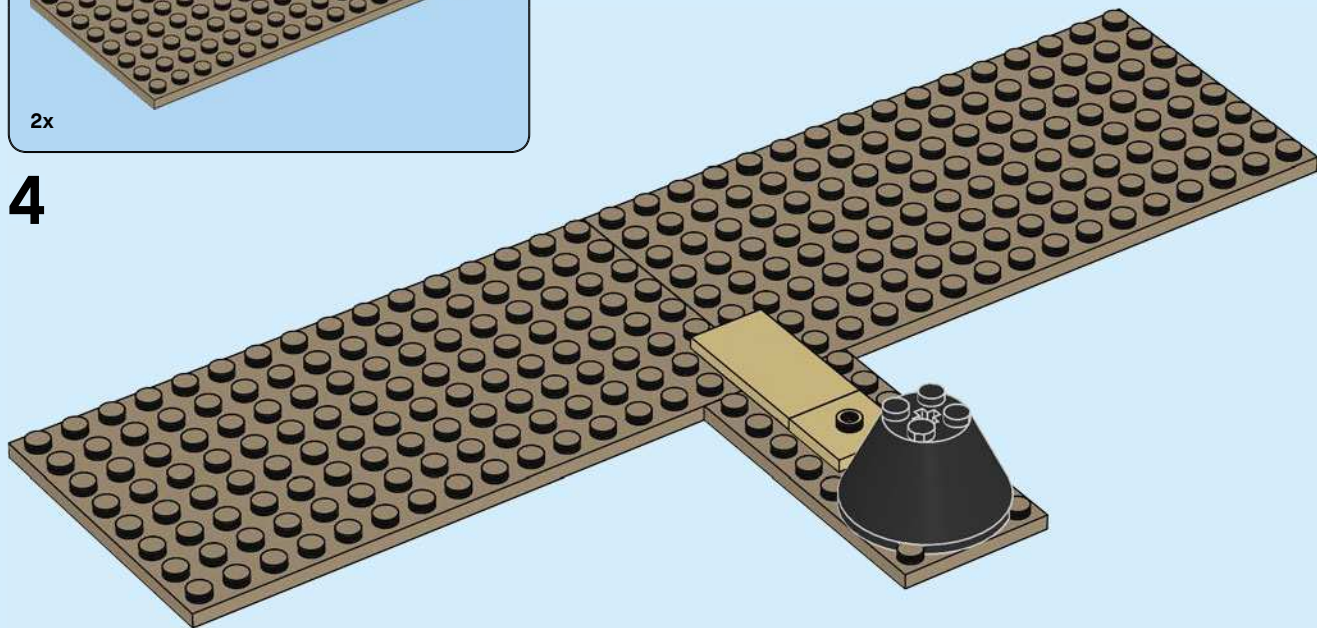

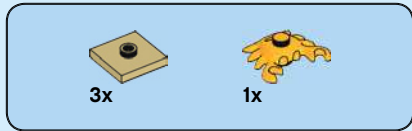

5

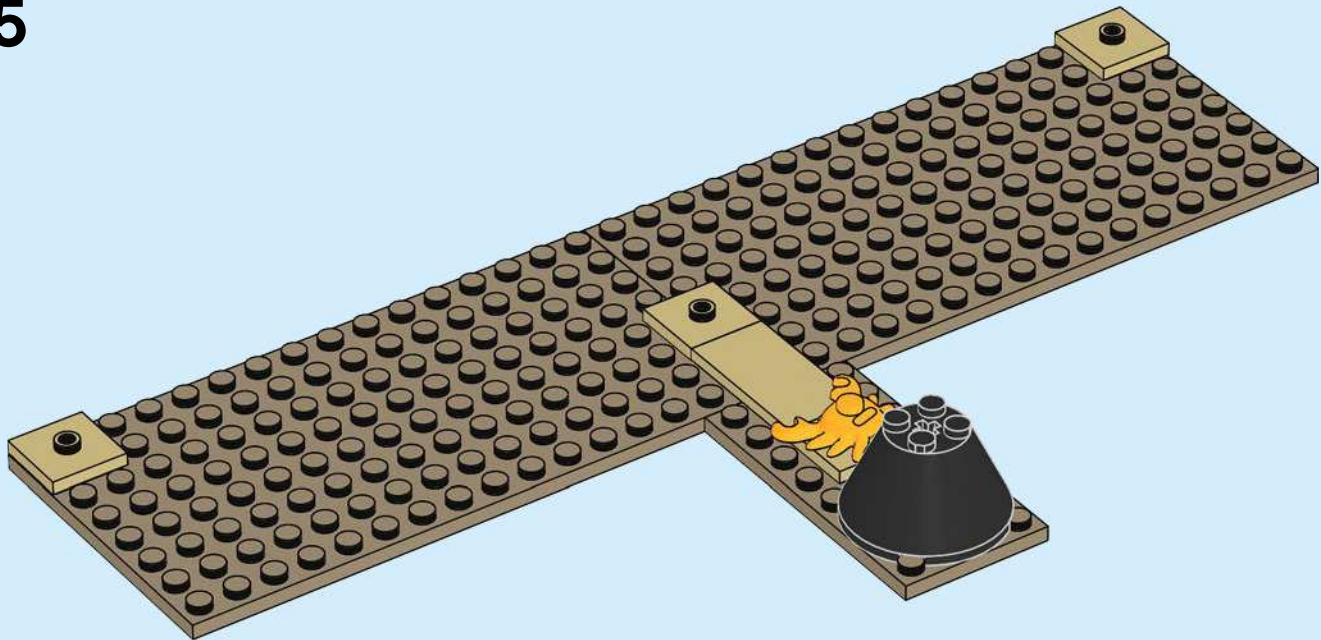

6

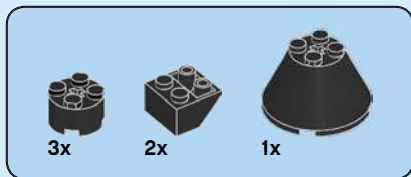

6

1



2

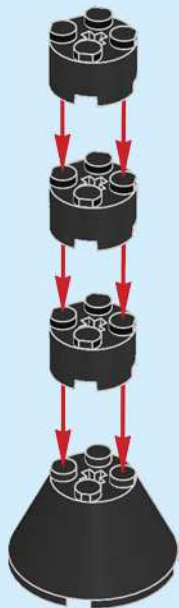

3

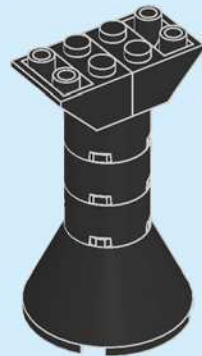

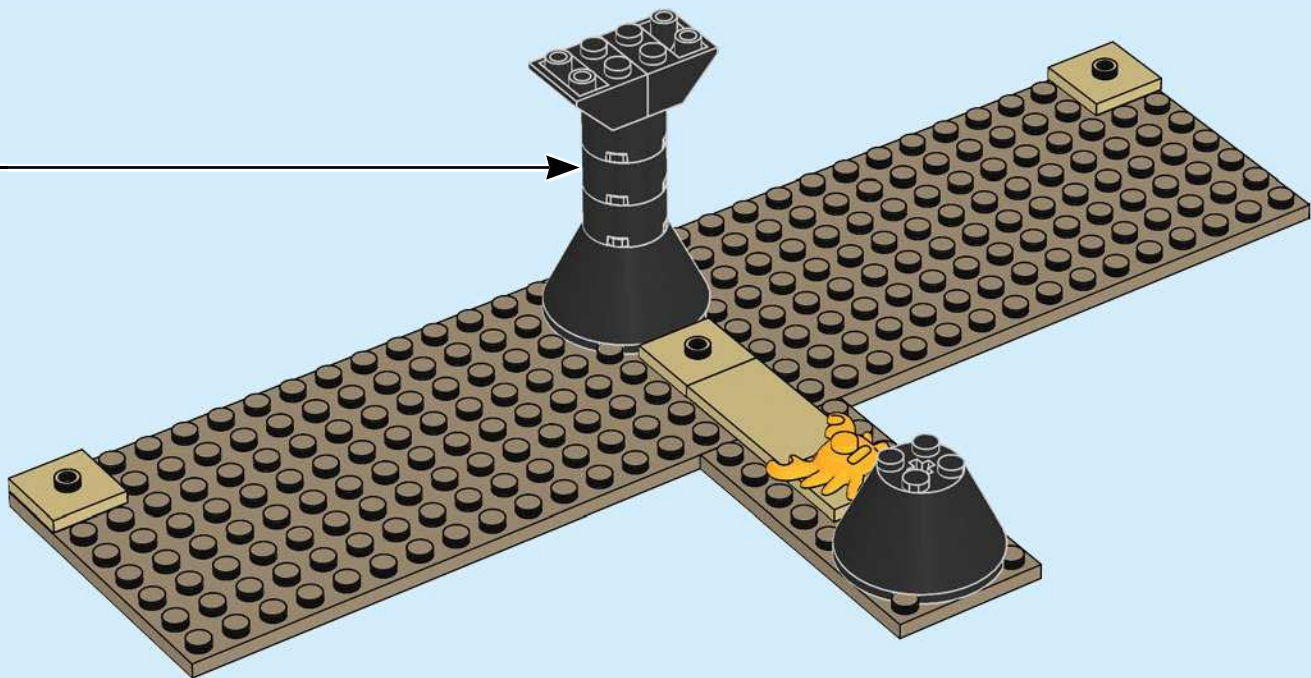



7

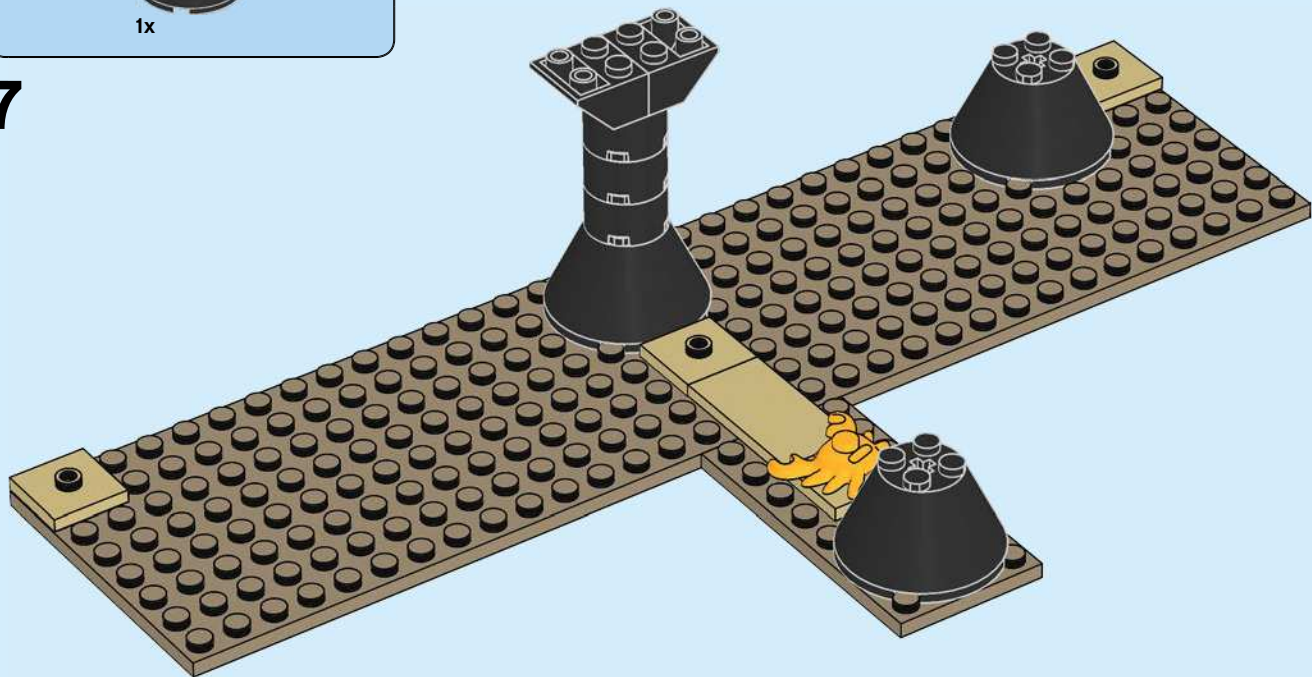



8x

8

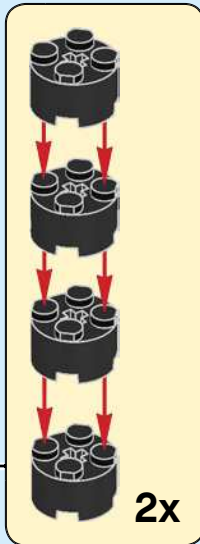
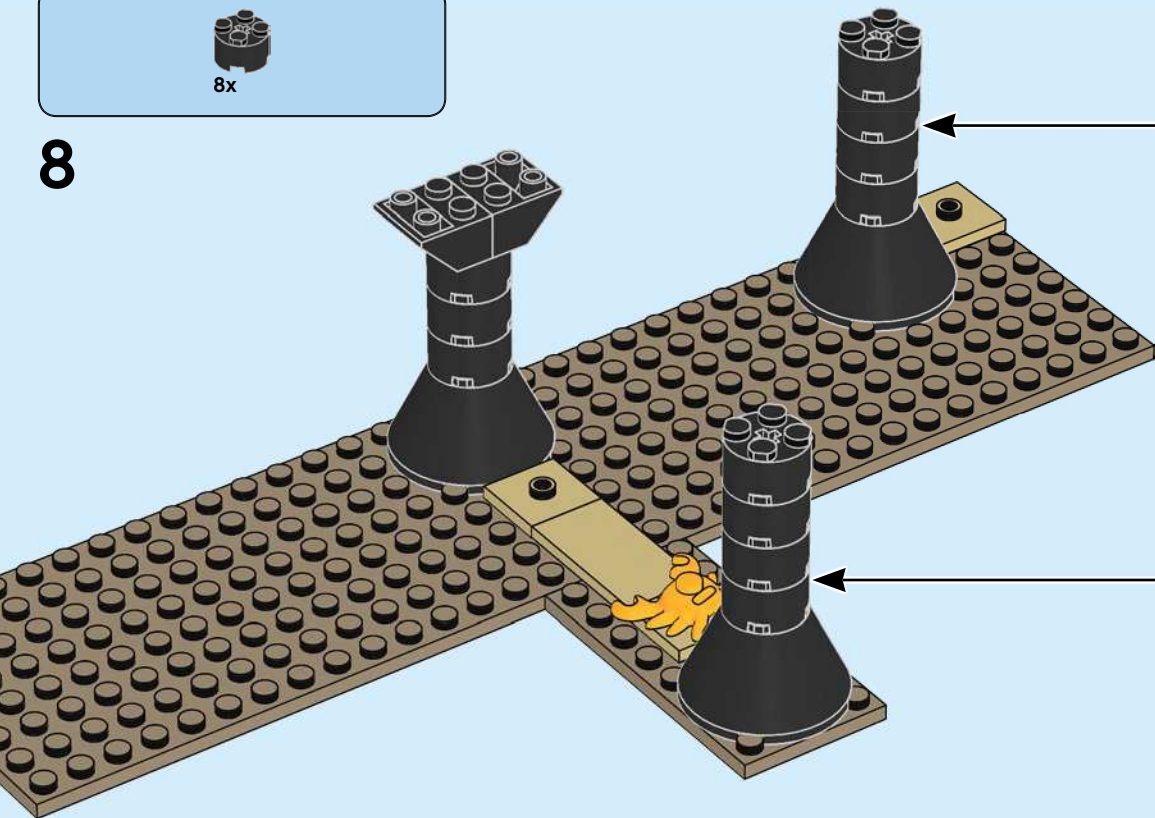

2x

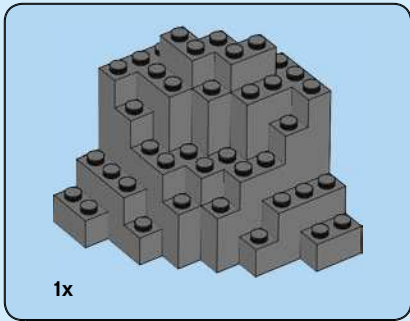

9

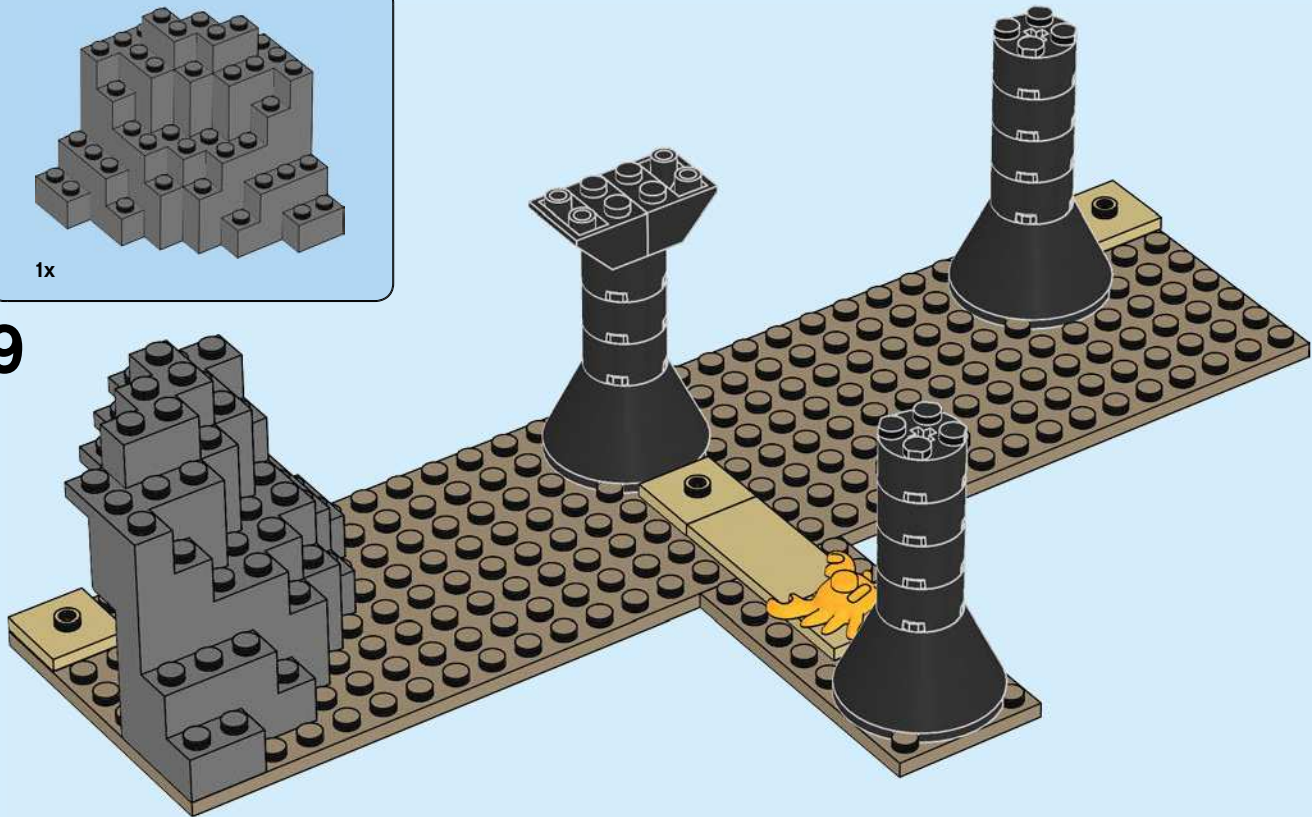



1x

10

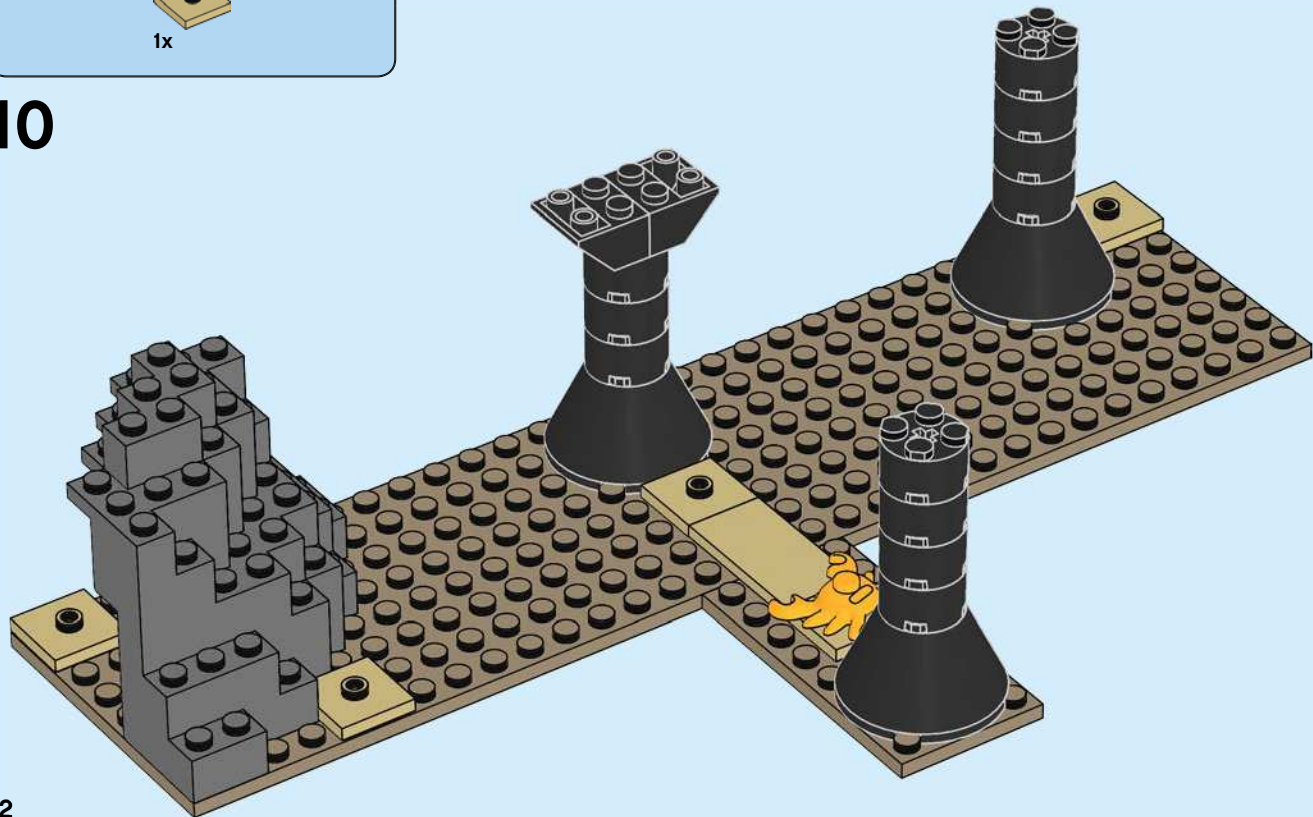

12



1x

11

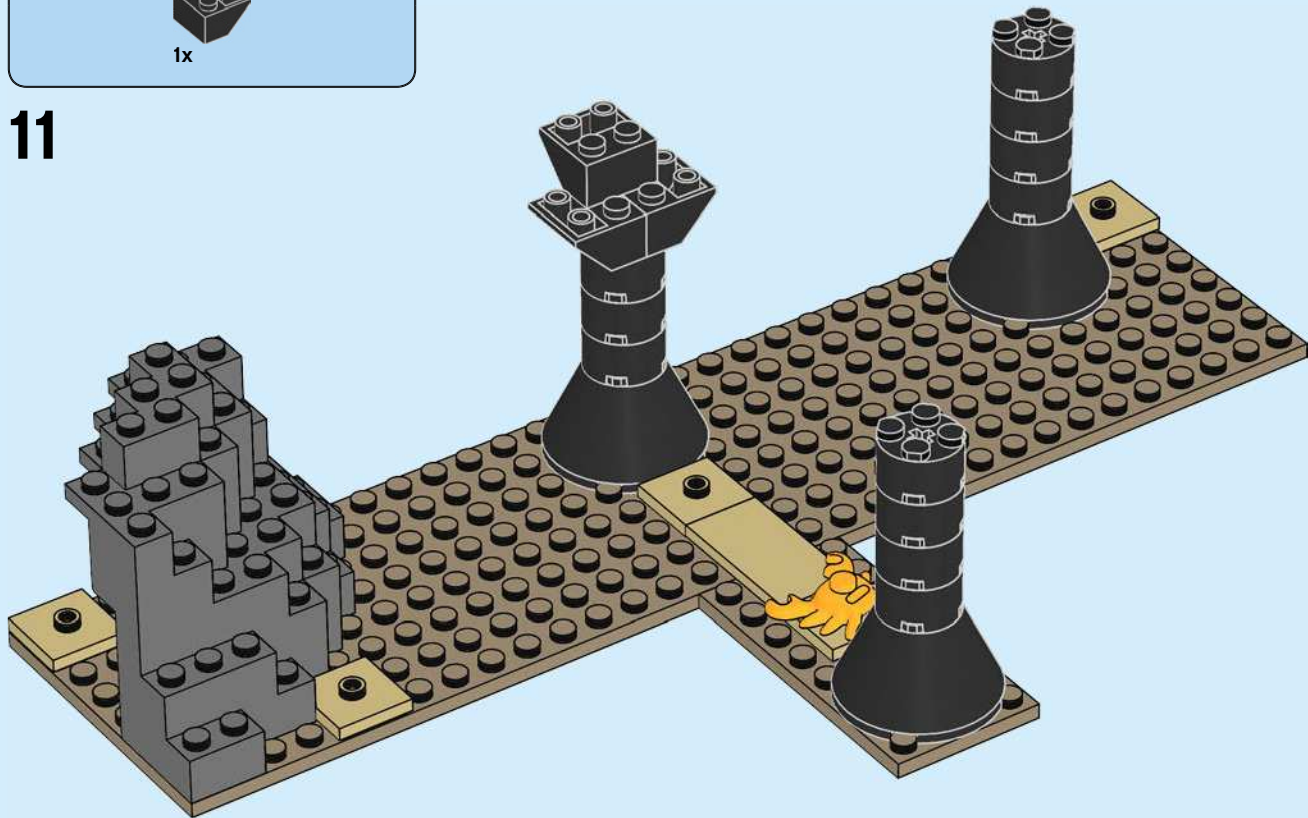

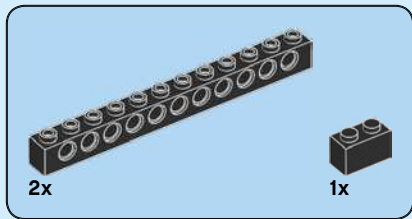

12

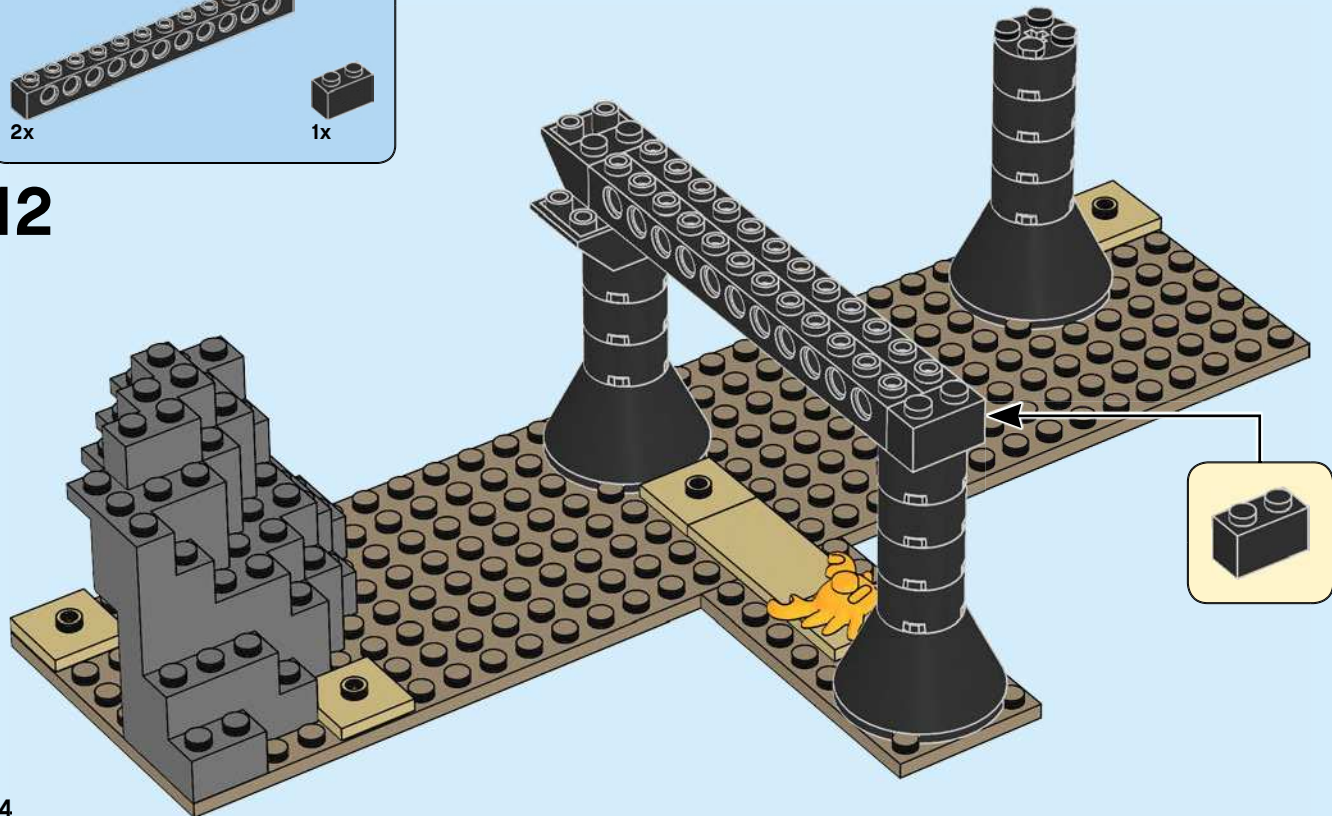

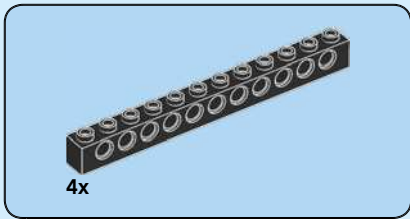

13

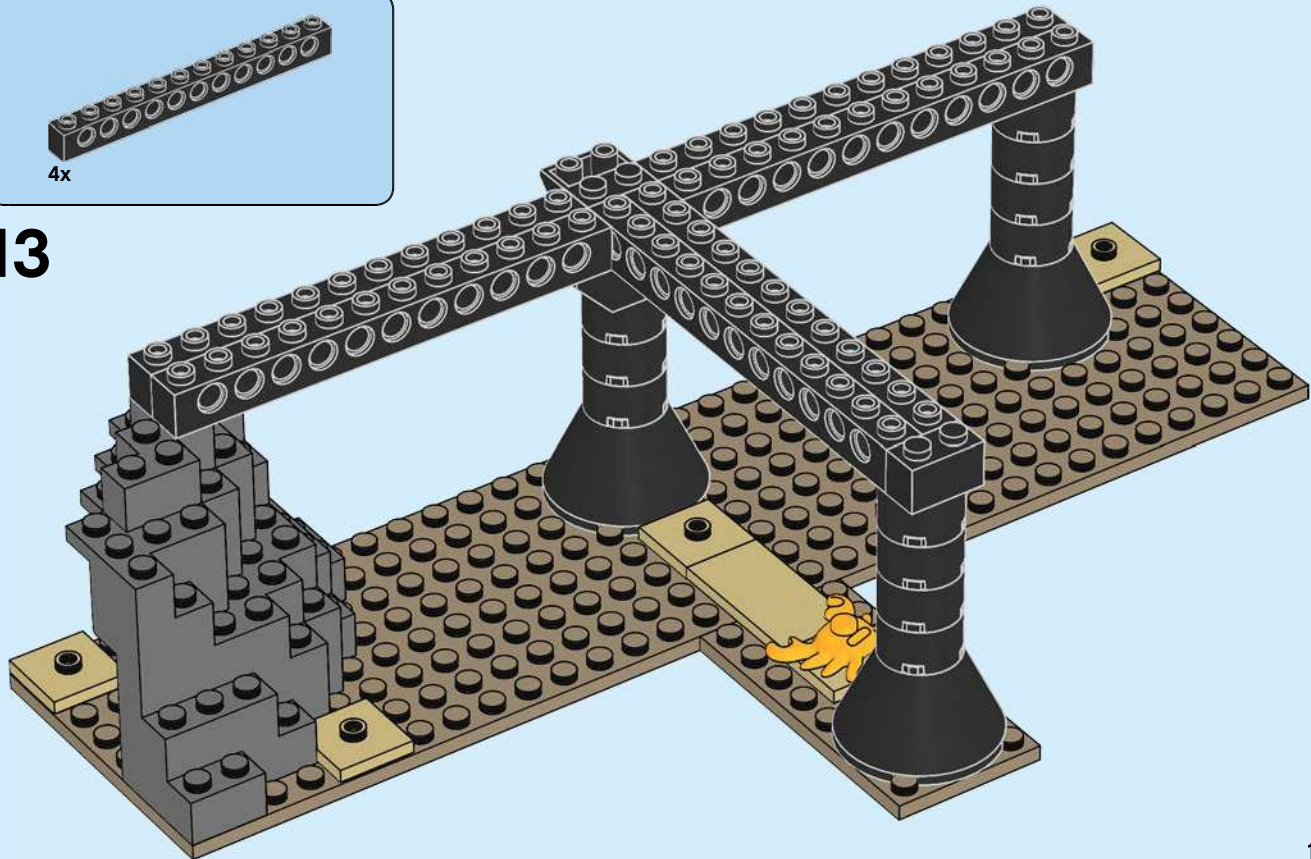

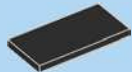

6x

14

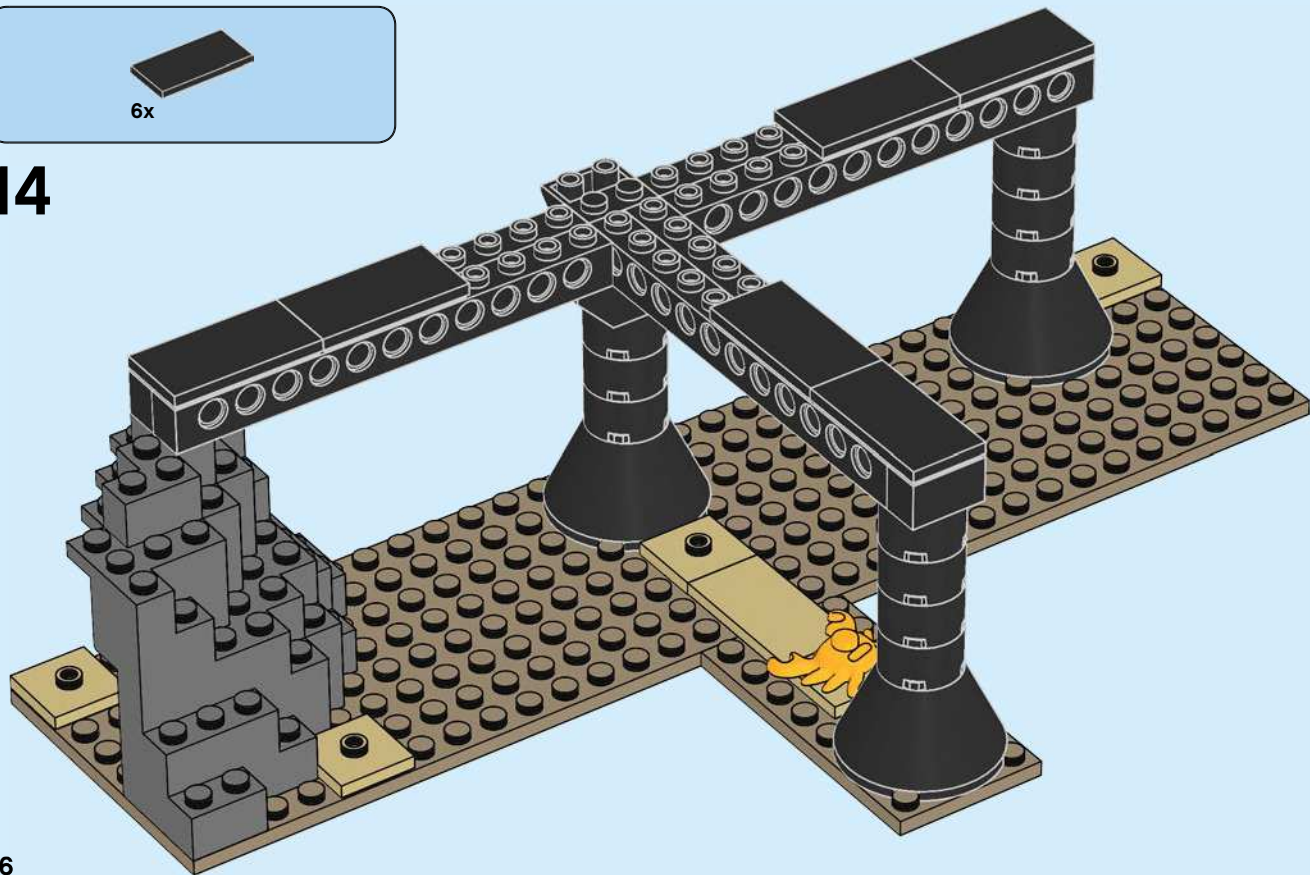

16

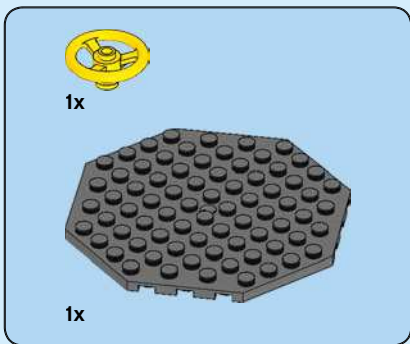
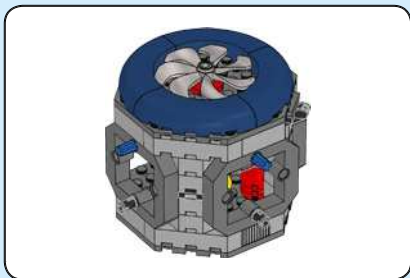

15

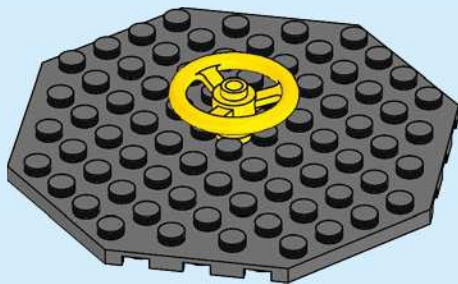

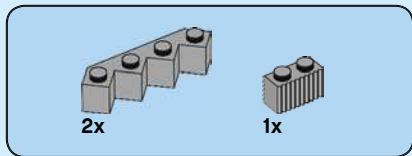

16

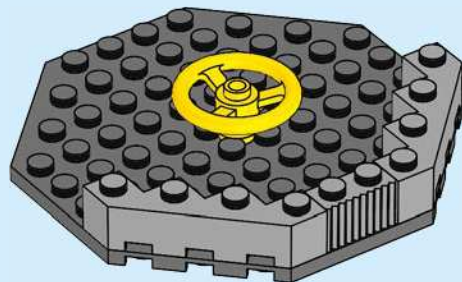



2x

17

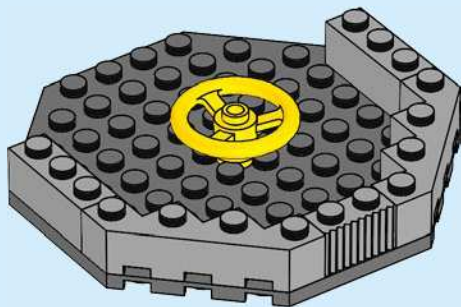



18

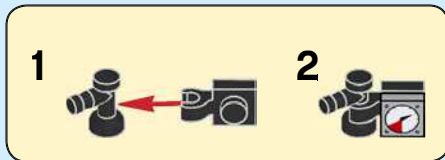
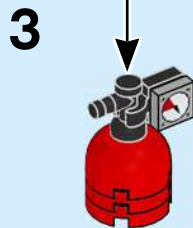
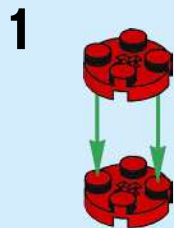

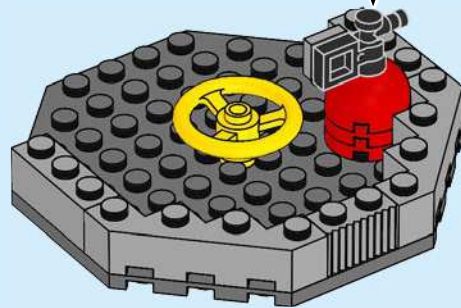

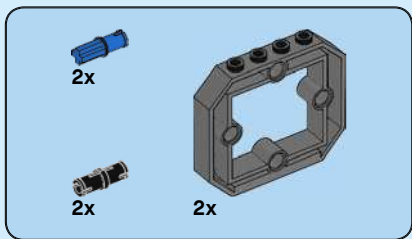
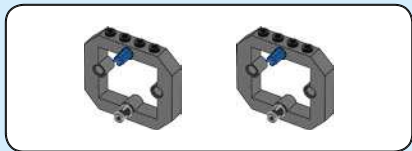

19

1

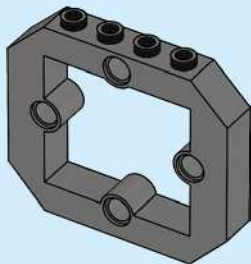

2

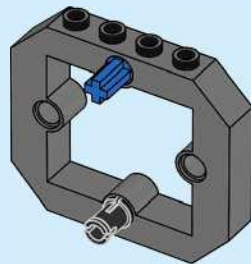

2x

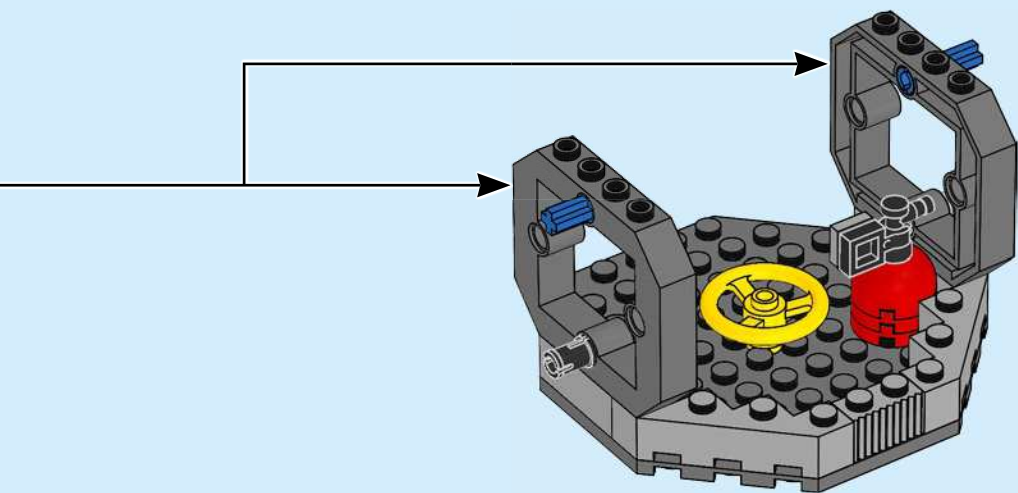

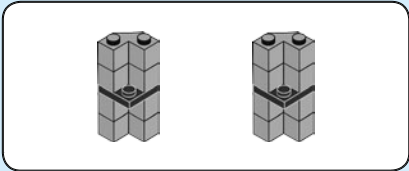

20

1

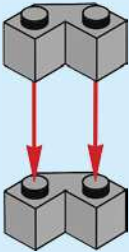

2



3

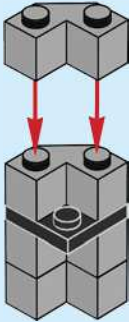

2x

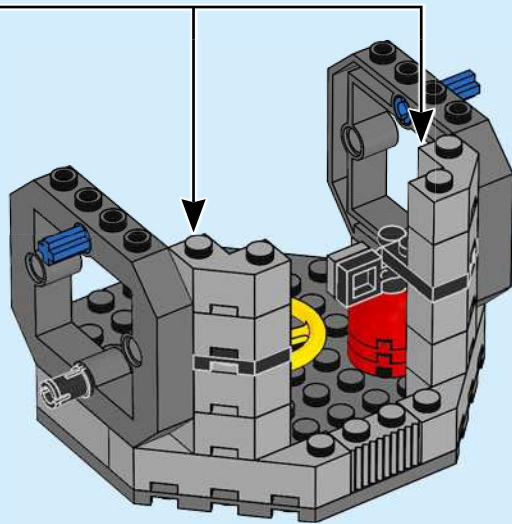

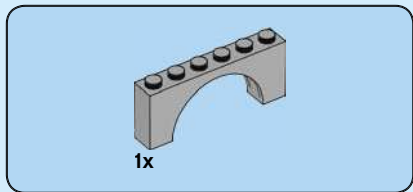

21

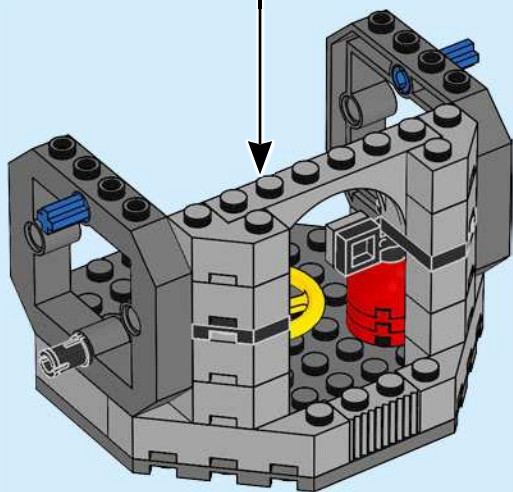
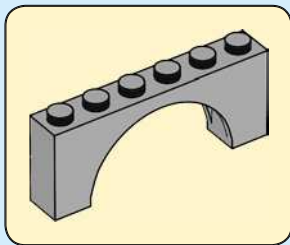

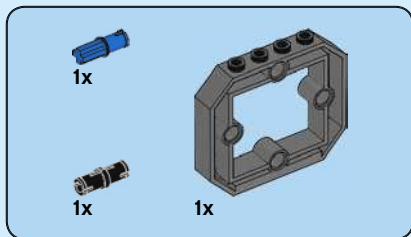

22

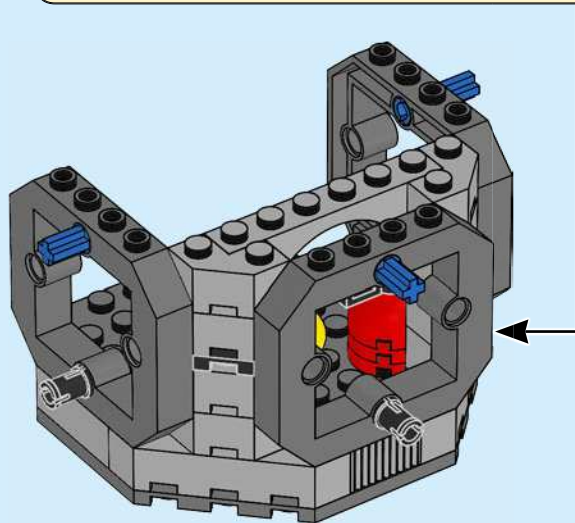
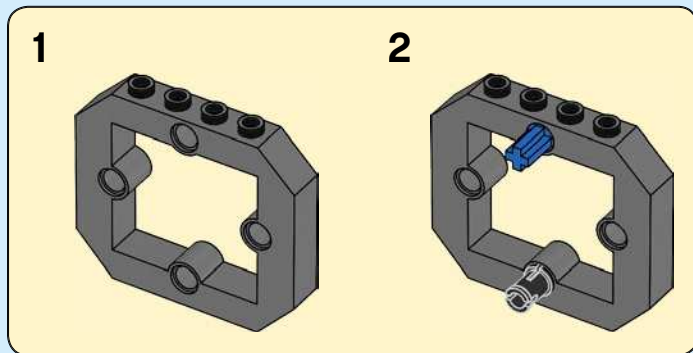



2x

23

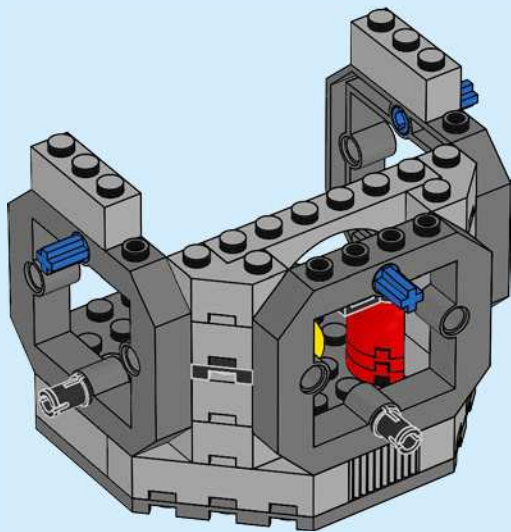

28

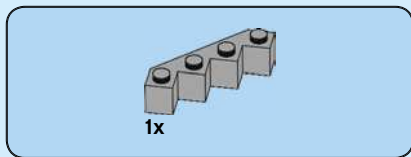

24

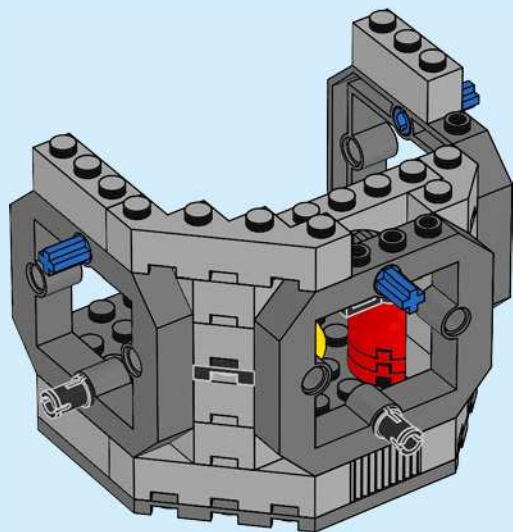



1x



1x

25

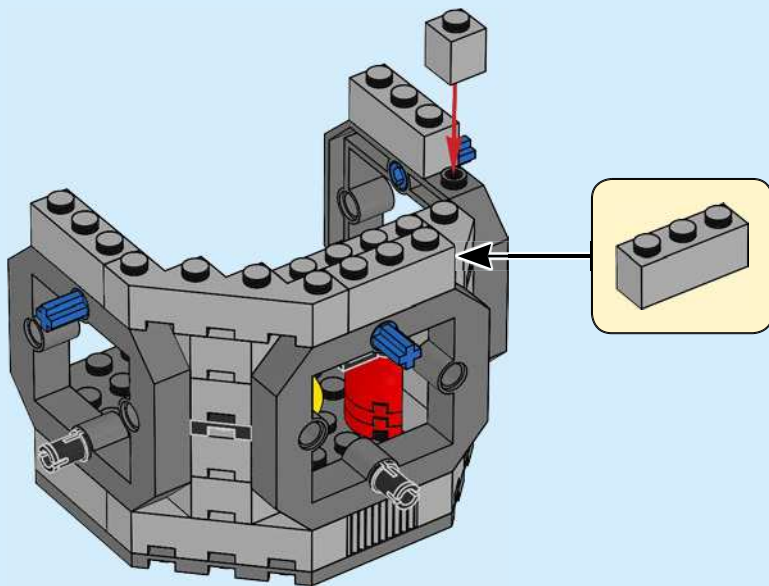

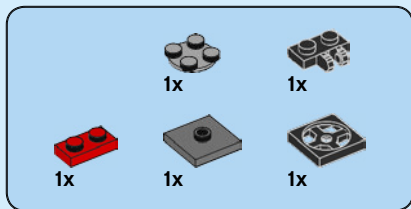

26

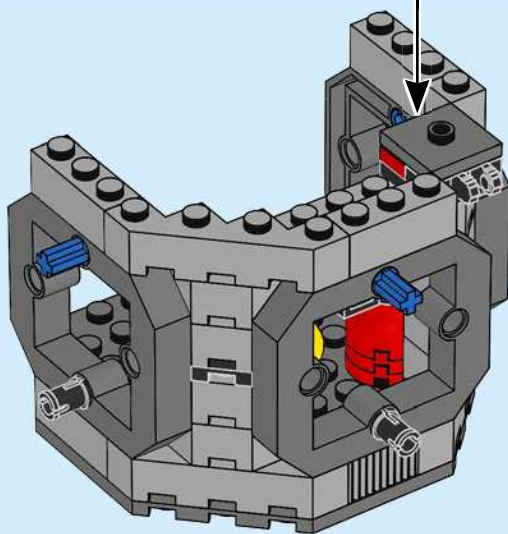

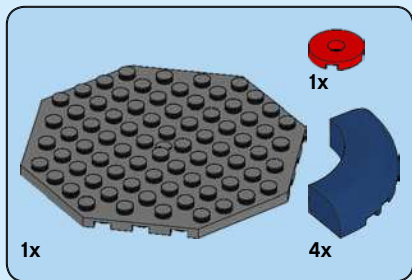

27

1

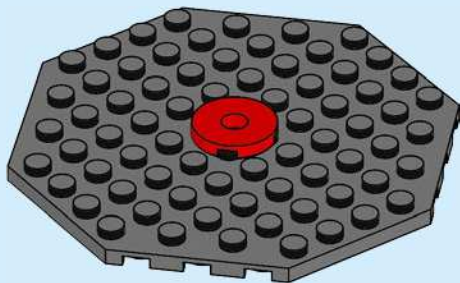

2

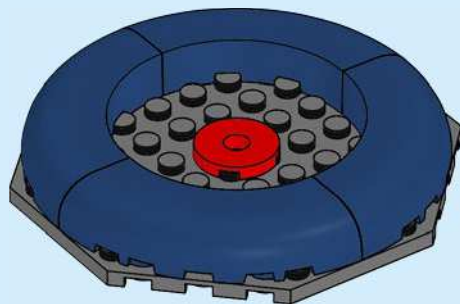

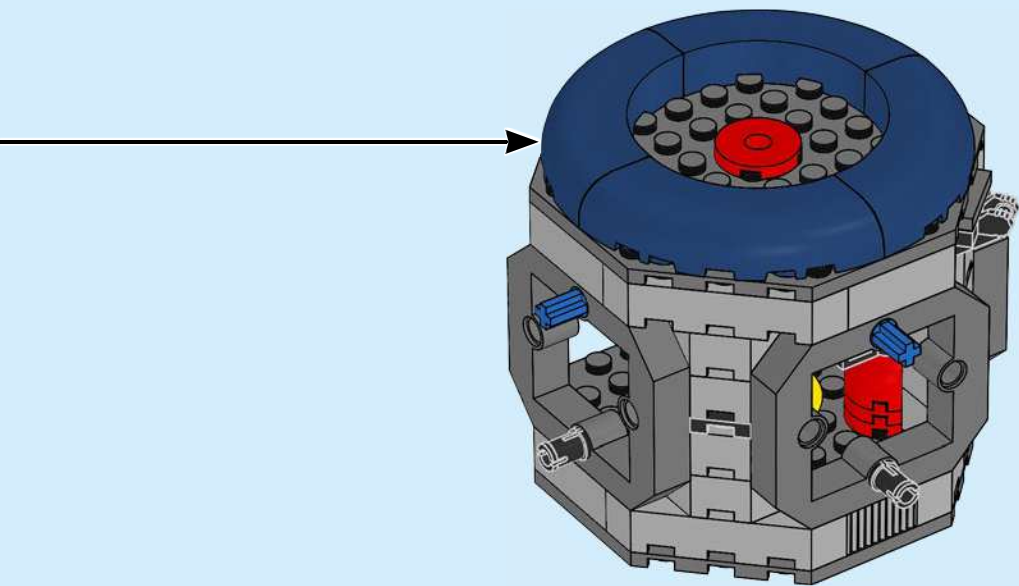

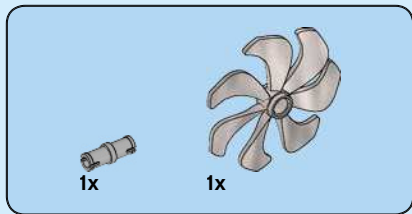

28

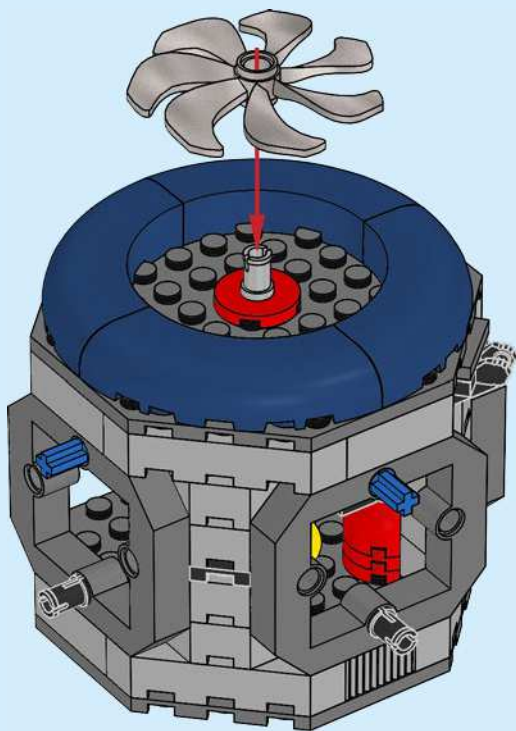

29

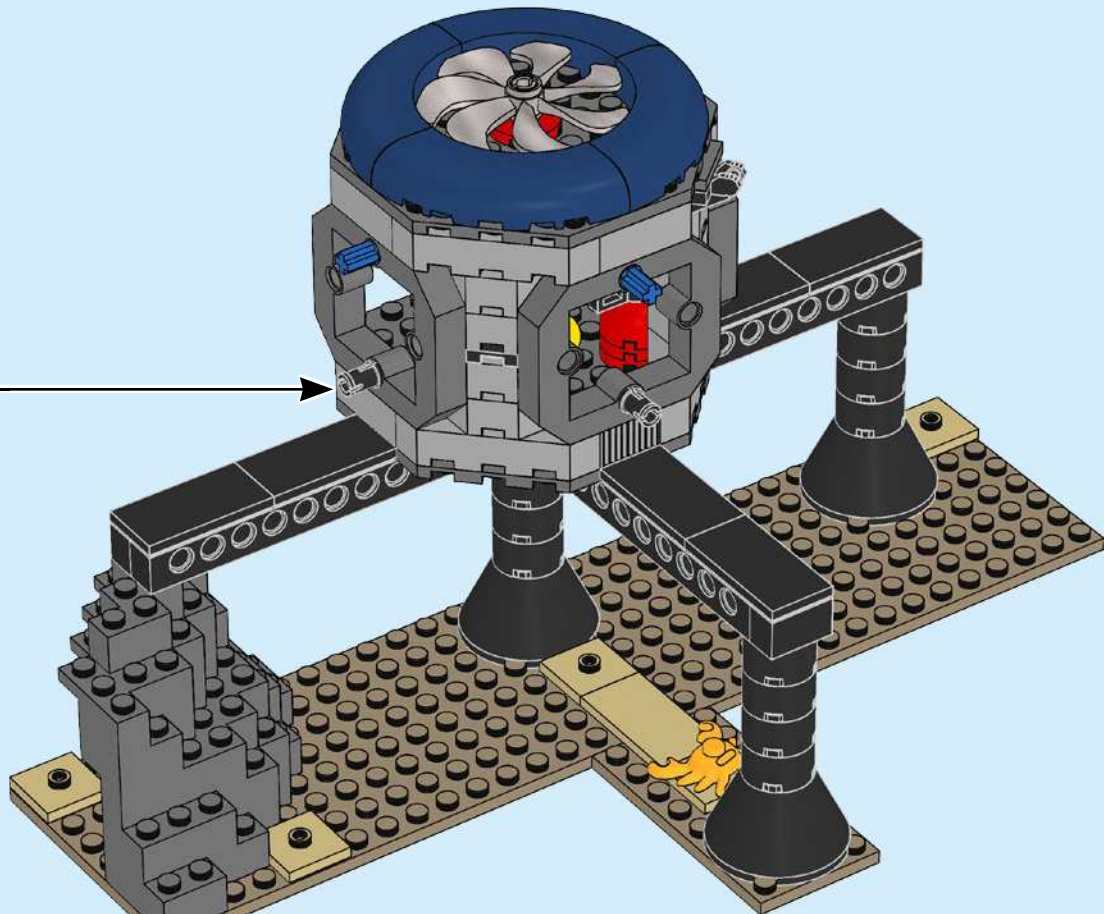



CITY



LEGO and the LEGO logo are trademarks of the LEGO Group. ©2020 The LEGO Group. 6324177
LEGO® City supports National Geographic Society Explorer Grants.
National Geographic Insignia and Identifiers have been provided by and used with permission of National Geographic.